

ESCLUSIVE SAFETY TECNOLOGIES

Safety at sea is our main priority. We manage all research, design and production processes with the utmost care so as to offer certified equipment for all nautical fields, with the highest production standards. All research and development activities are certified by the Department of Applied Science and Technology of the Polytechnic University of Turin, in accordance with EU regulations.

THE PRODUCTION PROCESS AND TRACEABILITY

With the aim of making inflatable life jackets more reliable, in 1994 Veleria San Giorgio introduced the Unique Product Code system. As the only manufacturer in the world to employ this type of technology, VSG is now able to identify all materials and individual components utilised through distinct alphanumeric codes.

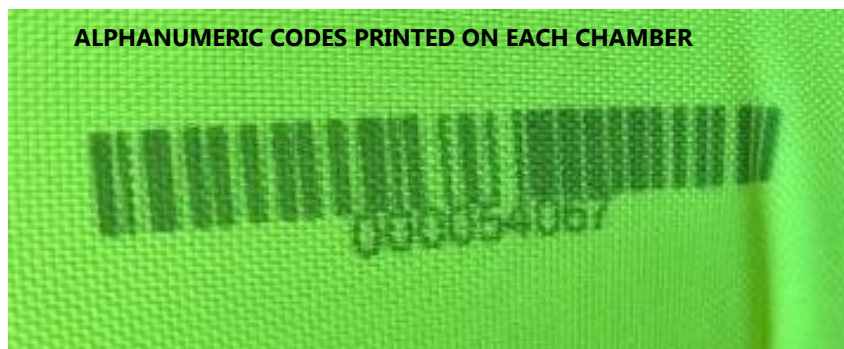

CERTIFICATO N. 26/91/S
CERTIFICATE No.

SI CERTIFICA CHE IL SISTEMA DI GESTIONE PER LA QUALITÀ DI
IT IS HEREBY CERTIFIED THAT THE QUALITY MANAGEMENT SYSTEM OF

VELERIA SAN GIORGIO S.R.L.

VIA A DE GASPERI 37H 16030 Casarza Ligure (GE) ITALIA
NELLE SEGUENTI UNITÀ OPERATIVE / IN THE FOLLOWING OPERATIONAL UNITS

VIA A DE GASPERI 37H 16030 Casarza Ligure (GE) ITALIA

È CONFORME ALLA NORMA / IS IN COMPLIANCE WITH THE STANDARD
ISO 9001:2015

Production processes are controlled via software specially developed by VSG, covering 100% of production so each product can be traced back to its buyer with absolute precision. This drastically reduces manufacturing defects (less than 1/10000 of returns), guaranteeing each buyer a unique product in the truest sense of the word and - most importantly - the highest degree of safety when needed.

Thanks to their ergonomic features, our life jackets guarantee an optimal position in the water and great stability. In addition, the vests offer enough buoyancy to rotate and tilt an unconscious person, so as to always keep the airway out of the water.

Spin - tilt

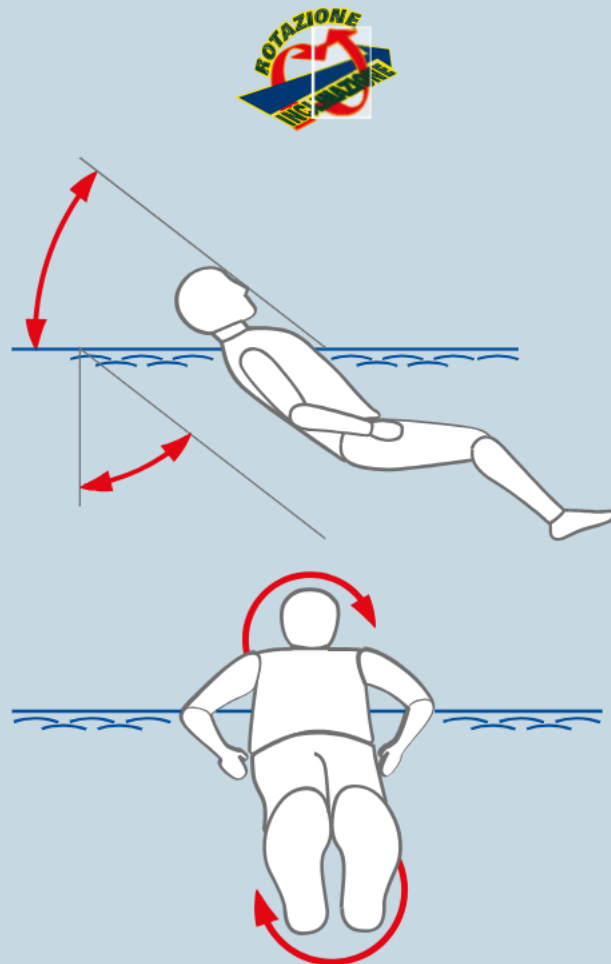

AIR BAG SMART ID VACUUM

ART. 09205/SMART/ID

Compact inflatable lifejacket. ISO 12402-3 certified, class 150, effective buoyancy 160 N, quick-release buckle closure system in acetal resin with integrated adjustment.

Designed for recreational activities in the open sea and/or under adverse weather conditions, with the possibility to safely await rescue even in rough waters. Provides maximum safety for any type of navigation.

Designed to maximise efficiency and bulk whilst minimising costs, designed as part of obligatory on-board equipment for sailing off the coast without limits.

MAIN FEATURES:

- Vacuum system packaging.
- Quick-release buckle with integrated adjustment.
- Recovery aid handle.
- Lifting handle.
- VSG RescueID -NFC Technology.



09205/SMART/ID/BOX



09205/SMART/ID



--	--	--	--	--	--	--

CODE	PRODUCT NAME	ACTION	ACTIVATORS
09205/SMART/ID	AIR BAG SMART 150	AUTOMATIC	UML MK5
09206/SMART/ID	AIR BAG SMART 150	MANUAL	UML MICRO MANUAL
09205/SMART/ID/BOX	AIR BAG SMART 150	AUTOMATIC	UML MK5
09206/SMART/ID/BOX	AIR BAG SMART 150	MANUAL	UML MICRO MANUAL
09205/SMART/ID/L	AIR BAG SMART 150 + light	AUTOMATIC	UML MK5
09205/SMART/ID/BOX/L	AIR BAG SMART 150 + light	AUTOMATIC	UML MK5

FEATURES	
Type	Compact inflatable lifejacket
Activators	UML MK5: (09205/SMART/ID - 09205/SMART/ID/BOX 09205/SMART/ID/L - 09205/SMART/ID/BOX/L UML micromanual: (09206/SMART/ID - 09206/SMART/ID/BOX) Oral tube on all versions.
Canisters	33 g 1/2" GAS threading on all versions
Effective buoyancy	160N
Class	150
Fastening mechanism	Quick-release clasp in acetal resin with integrated adjustment
Certification	ISO 12402-3
Size	Adult
Weight supported	> 40 kg
Waist circumference	80 - 125 cm
Chamber	Single, PA 420 PU COATED material, fluorescent yellow in colour
Product packaging	Material VACUUM SEALED PE BAG, transparent, tear open Material VACUUM SEALED PE BAG transparent, tear open and cardboard box.
Product dimensions	24 x17 x 3 cm approx (Vacuum) 26 x 38 x 4 cm approx (Cardboard Box)
Product weight	09205/SMART/ID (600 g approx) 09205/SMART/ID/BOX (670 g approx)
Packaging	60x40x40cm 16 pcs 09205/SMART/ID/BOX 60x40x20cm 20 pcs 09205/SMART/ID
Service	Every 24 months
Accessories on request	Automatic emergency light, PVC casing
Spare parts	Whistle, rearming kit
Veleria San Giorgio reserves the right to modify the technical specifications without prior notice	

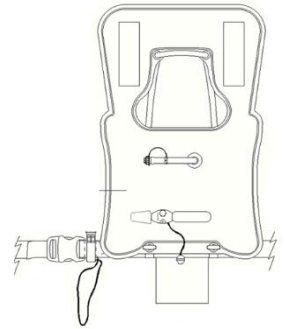
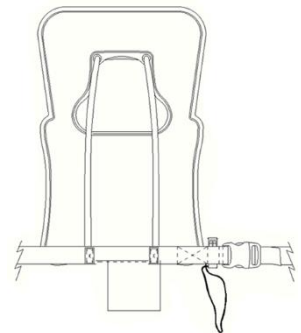
FRONT**REAR****TO WEAR**

1. Tear open the bag and extract the chamber



2. Put on the chamber



3. Fasten the waist strap and adjust it.

This ISO 12402-3 certified lifejacket is one of the smallest and most compact in the world thanks to its vacuum technology, which drastically reduces its size by up to 75% compared to traditional models, with a significant reduction in the materials used, facilitating disposal and maintenance. Its transparent protective cover, permeable to radio waves, ensures the contents remain hermetically sealed until use, preserving the efficiency and functionality of all integrated safety and support elements. The vacuum solution not only reduces the space occupied, facilitating storage and transport, but also ensures the casing remains intact and is not accidentally opened, maintaining the safety features of the lifejacket even after long periods of storage, until needed. Furthermore, in the event of accidental fall into water, it allows it to float.

Floatation chamber with single compartment in PA 420 PU COATED material with electronically-controlled high-frequency sealing. Provides optimal positioning and perfect stability in the water. The thrust is strong enough to rotate an unconscious person and tilt them, allowing their airways to remain clear of water. Even with the chamber inflated, it is possible to swim easily to reach a safe place or quickly climb onto a lifeboat.

ACTIVATION SYSTEMS

Automatic: in the event of a fall into the sea, the system is submerged and automatically activates inflation of the buoyancy chamber within 5 seconds. Automatic activation is possible with the UML MK5 salt activator, by dissolving a water-soluble tablet.

Manual: in the event of falling into the sea, the system must be activated manually by pulling the yellow lever forcefully to inflate the lifejacket using the special cord connected to the MICRO MANUAL activator.

Oral: this type of inflation is performed using the special oral tube, check valve and protective cap. To inflate the chamber, simply blow into the oral tube.



VSG RescueID

A revolutionary innovation for maritime safety.

In the world of maritime safety, innovation and technology are essential for saving lives, improving the efficiency of rescue operations and reducing environmental impact. We present a cutting-edge product that redefines safety standards: the compact, inflatable lifejacket with integrated radio frequency programming and identification technology (VSG RescueID).

Contactless NFC technology

Programming and updating personal, medical, and emergency data without opening the container, simply by placing a smartphone or tablet nearby



Advanced features

Scannable label that allows first responders and crew to quickly access essential user data.



Pat. Pending

TO UPLOAD YOUR PERSONAL DATA AND YOUR BOAT DATA

Hold your phone close to the tag (if the pop-up does not appear on your phone, enable NFC)

Click on the pop-up that takes you to the Android or Apple Store

Click on your operating system and you will be directed to the app to download. Download and register on the app with the required information.

After registering, you may be asked to add a device.

When adding the device, you can enter the name and registration number of the boat, as well as other information.

TO READ THE DATA

Hold your phone close to the label: view and click on the link/pop-up.

The options also include SOS, which allows you to send the exact location of the lifejacket to the emergency contact you have entered.

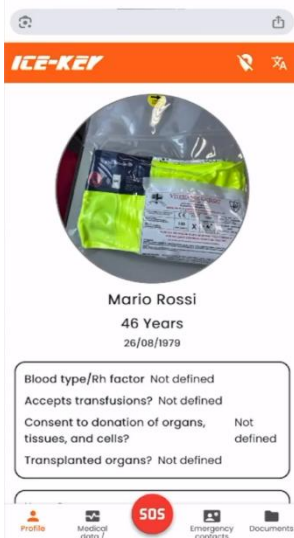

VACUUM TECHNOLOGY

This technology has been exclusively developed and applied by Veleria San Giorgio to improve resistance to atmospheric agents and ensure longer-lasting durability.

Tests carried out in accordance with international SOLAS standards demonstrate the efficiency of the Vacuum System compared to other packaging methods.

The Vacuum product is placed in the conditioning chamber exactly as it is sold to the public. Tests are conducted on the product in its vacuum-sealed PVC packaging.

CLIMATIC CYCLE TESTS AND AGEING SIMULATION

Test Method: - IMO Resolution MSC.200(80)

Equipment : - Climatic chamber type UY1200

Laboratory : - RINA Service SpA

The vacuum product was tested according to the test method specified in IMO Resolution MSC.200(80). Conditioning was performed in a climatic chamber with temperature cycles of +65°C for 8 hours and -30°C for 8 hours, for a total of 10 cycles.

The thermal cycling test was successful, showing no damage to the products and meeting standard requirements.

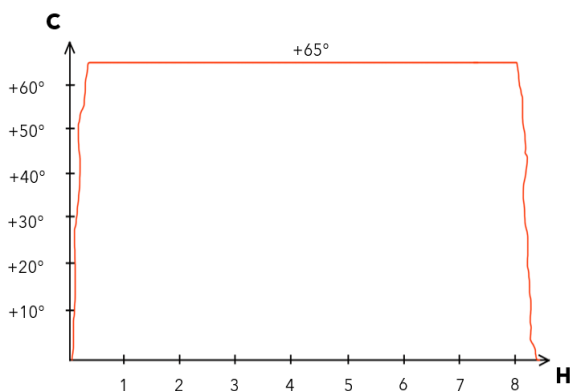

Single 8-hour cycle at +65°C

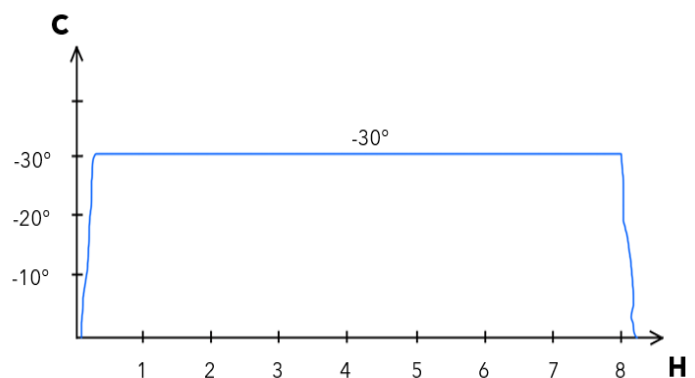

Single 8-hour cycle at -30°C

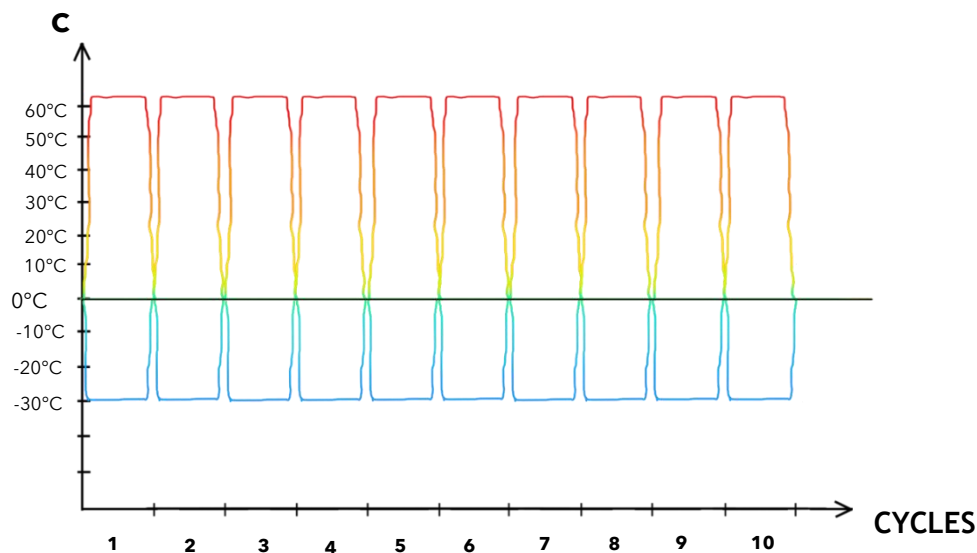

10 cycles of 8 hours each at -30°C and +65°C

SPARE PARTS

	Whistle	25180
	A mandatory accessory that permits an emergency sound signal. ISO 12402-8 certified	

Rearming
UML: rearming kit (26233), water-soluble tablet (25005), green MK5 pin (25003/MK5) Canister 33 g (26033)

ACCESSORIES

	Led light	03030
	Automatically activates upon falling into the water. Renders the device visible for up to a mile.	

	PVC casing	11009/C
	PVC casing for 4/6 AIR BAG SMART (Code 09205/SMART)	



Remember to conduct a periodic inspection.
Book an inspection now by emailing us at: info@veleriasangiorgio.com or go to the website.



For more information, contact us at +39 0185 467701 or via our website veleriasangiorgio.com



To buy or learn more about this product, please refer to the QR Code or visit veleriasangiorgio.com

LIFE JACKETS AND LIFE BELTS, FLAGS AND BANNERS, TECHNICAL ITEMS, PERSONAL PROTECTIVE EQUIPMENT AND SAFETY GEAR FOR CIVILIAN AND MILITARY FIELDS Via Alcide De Gasperi, 37H - 16030 Casarza Ligure
- Genoa - Italy Tel. +39 0185 467701 - Fax +39 0185 467050 - info@veleriasangiorgio.com - www.veleriasangiorgio.com



**VELERIA
SAN GIORGIO®**

LIFEJACKET MANUFACTURER